

### Replacement Parts List

**NOTE:** If requested color is not available, similar color will be substituted.

Part	Cost	Quantity	Total Cost
Crotch Strap/Buckle	\$4.99	X _____	= \$ _____
Harness Strap	\$2.00	X _____	= \$ _____
Pad Set	\$42.00	X _____	= \$ _____
Harness Retainer	\$1.50	X _____	= \$ _____
Locking Clip	\$2.50	X _____	= \$ _____
Tether Kit	\$9.99	X _____	= \$ _____
Latch Kit	\$24.99	X _____	= \$ _____
Instructions	\$0.00	X _____	= \$ _____

**Merchandise Total** \$ \_\_\_\_\_

**Shipping and handling:** \$ \_\_\_\_\_

Up to \$25.00	.....\$5.95	\$100.01 to \$150.00	.....\$10.95
\$25.01 to \$50.00	.....\$6.95	\$150.01 to \$200.00	.....\$11.95
\$50.01 to \$75.00	.....\$8.95	\$200.01 and up	.....\$13.95
\$75.01 to \$100.00	.....\$9.95	Outside Continental USA	\$10.00

**Sales Tax** \$ \_\_\_\_\_  
 (Indiana, California, and Massachusetts residents add applicable sales tax.)

**Grand Total** \$ \_\_\_\_\_

No shipping and handling on instructions for quantities under 6. Add \$.50 for each instruction over 6, then add applicable shipping and handling.

**Fill Out For Credit Card**

Visa     Mastercard

Card Exp. Date: \_\_\_\_\_

Cardholder's Name: \_\_\_\_\_

Card Number: \_\_\_\_\_

Signature \_\_\_\_\_

CUT ON DOTTED LINE

Eng. 4358-3340D

# Alpha Omega® Elite/Luxe Deluxe 3-In-1 Owner's Manual

www.djgusa.com



This child restraint is designed for use by children whose:

**Weight:**  
5-100 pounds  
(2.3-45.4 kg)

**Height:**  
19-52 inches  
(48-132.1 cm)

Read all instructions  
**BEFORE USING**  
this child restraint.

KEEP INSTRUCTIONS FOR FUTURE USE.

**⚠ IMPORTANT!**

**Failure to follow the warnings on the labels and in the instruction manual can result in the death or serious injury of your child.**

Para recibir las instrucciones en español, llame al 1-800-544-1108 o solicítase por escrito al dirección por arriba.

## Before You Begin...

Thank you for choosing this car seat, referred to throughout this manual as a child restraint. The DJG family is committed to creating a child restraint with the most comfort and convenience available today.

Remember, parents are a child's first teachers and examples. If you always buckle your seat belt, your child will think it is the natural thing to do. Make it a firm rule that the vehicle does not go until everyone is buckled up. Make no exceptions.

No one can predict if use of a child restraint will prevent injury or death in a particular crash. However, combined with careful driving, proper use of a child restraint can lower a child's risk of injury or death in most crashes.

Your child's safety is worth the time it will take to read and follow these instructions. After reading, if you still have questions or have any problems with this child restraint, please contact our Consumer Relations Department at:

### Dorel Juvenile Group, Inc.

Website: [www.djgusa.com](http://www.djgusa.com)  
 Fax: 1-800-207-8182  
 Mailing Address: Dorel Juvenile Group, Inc.  
 P.O. Box 2609  
 Columbus, IN 47202-2609  
 Telephone: 1-800-544-1108  
 7 A.M. to 6 P.M. EST M-TH  
 7 A.M. to 4:30 P.M. EST FRI

On the back of the shell there is an expiration date for use of this child restraint. Do not use this seat after the expiration date.

## Table of Contents

Warnings.....	2-4
Registration and Recall .....	5
General and Warm Weather Use.....	5
Aircraft Installation .....	5
Understanding Your Vehicle .....	6-7
Child Restraint Parts.....	8-9
Choosing Restraint and Position .....	10
Preparing the Child Restraint to Fit Your Child.....	11
Check Harness/Headrest Height.....	12-13
Securing Your Child in the Child Restraint .....	14-15
Removing Your Child From Child Restraint .....	16
Reclining the Child Restraint .....	17
Rotating Armrests .....	17
Choosing LATCH or Vehicle Belts.....	18
Knowing Your Vehicle Belts .....	19-20
Locking Clip .....	21-22
Rear-Facing Use .....	23
Rear-Facing Installation.....	24
Vehicle Belts .....	25-26
LATCH.....	27-30
Forward-Facing Use .....	31
Forward-Facing Installation .....	32
Vehicle Belts .....	33-34
LATCH.....	35-37
Adjusting the Top Anchorage (Tether) Strap.....	38
Belt-Positioning Booster Use .....	39
Removal of Seat Base .....	40
Removal of Harness .....	41-42
Belt-Positioning Booster Installation.....	43-44
Reinstall Harness and Base .....	45-46
Remove Seat Pad for Cleaning.....	47-48
Trouble Shooting .....	49
Warranty .....	50
Replacement Order Form.....	53-54

## WARNING

Failure to follow these warnings can result in the serious injury or death of your child. To help you recognize those instructions which are most critical for your child's safety, we use this symbol :

 According to accident statistics, children are safer when properly restrained in the rear seating positions than in the front seating positions.



 Never place a child rear-facing in a seating position with an active frontal airbag.

 This child restraint must always face the rear of the vehicle and be in the fully reclined position when the child weighs between 5-35 lbs. (2.3-16 kg) and is less than one year old.

 Never place a child less than one-year old forward facing.

 Check vehicle instructions for more information about air bag/child restraint use.

 Make sure the harness height is correct for your child's size.

 The harness strap must be snug.

 Never take your child out of the child restraint or try to tend to your child's needs while the vehicle is moving. Never leave child unattended.

2

## WARNING

 The vehicle or LATCH belt must stay tight at the belt path. When you switch from one mode to the next, review the sections of this instruction manual that apply to that mode. If you don't, your child could be injured or killed.

 Do not use a child restraint with damaged or missing parts.

 Do not use cut, frayed or damaged harnesses.

 Do not lubricate buckles and fasteners.

 Do not substitute parts or try to modify the child restraint in any way.

 Do not use a child restraint that has been in a crash. You must get a new child restraint.

 Use the child restraint only on vehicle seats that face forward. Do not use on seats that face the sides or rear of the vehicle.

 Check the vehicle or LATCH belt before each use. Use only if the belt can be tightened properly and securely.

 This child restraint should be securely belted in the vehicle even when not in use. In a crash or sudden stop, an unsecured child restraint could injure other occupants.

3

## **WARNING**

 **Do not use this child restraint if the midpoint of your child's head is above the top of the child restraint's headrest.**

 **Dorel Juvenile Group does not recommend the use of any child restraint accessories except those recommended by DJG.**

 **Never allow any child to play with this child restraint; it is not a toy.**

 **Secure the top anchorage strap (tether) provided with this child restraint as specified in both the vehicle and child restraint manufacturer's instructions.**

 **Do not remove any of the warning labels or other labels on the child restraint.**

 **Placing you child in a hot child restraint may result in burns.**

 **Read instructions for other warnings.**

## **General and Warm Weather Use**

To help protect your vehicle seat's upholstery from damage, use a towel underneath and behind child restraint.

**To avoid your child being seriously burned, take the following precautions:**

1. Park in the shade or where sun does not directly hit the child restraint.
2. Cover the child restraint with a sheet or blanket when not in use.
3. Check for hot seat and buckles before placing child in child restraint.

## **Registration and Recall Information**

Child restraints could be recalled for safety reasons. You must register this restraint to be reached in a recall. Send your name, address and the restraint's model number and manufacturing date to:

Dorel Juvenile Group, Inc.  
PO Box 2609, Columbus, IN 47202-2609  
Attn: Consumer Relations or visit [www.djgusa.com](http://www.djgusa.com)  
or call 1-800-544-1108

For recall information, call the U.S. Government's Vehicle Safety Hotline at 1-888-327-4236 (TTY: 1-800-424-9153), or go to <http://www.NHTSA.gov>.

## **Aircraft Installation**

This restraint is certified for aircraft use only when used with the internal harness. Do not use as a belt-positioning seat because aircraft seats do not have shoulder belts. Use on forward-facing aircraft seats only and in a position where the lap belt can be tightened securely. This child restraint is installed in an aircraft seat the same way it is installed in the vehicle.

Use the child restraint only with F.A.A. certified equipment. Contact the airline prior to taking a child restraint on board in order to comply with their specific regulations.

## Understanding Your Vehicle

Your vehicle's features may be considerably different than those pictured here. Consult your vehicle owner's manual to help identify your vehicle's specific features.

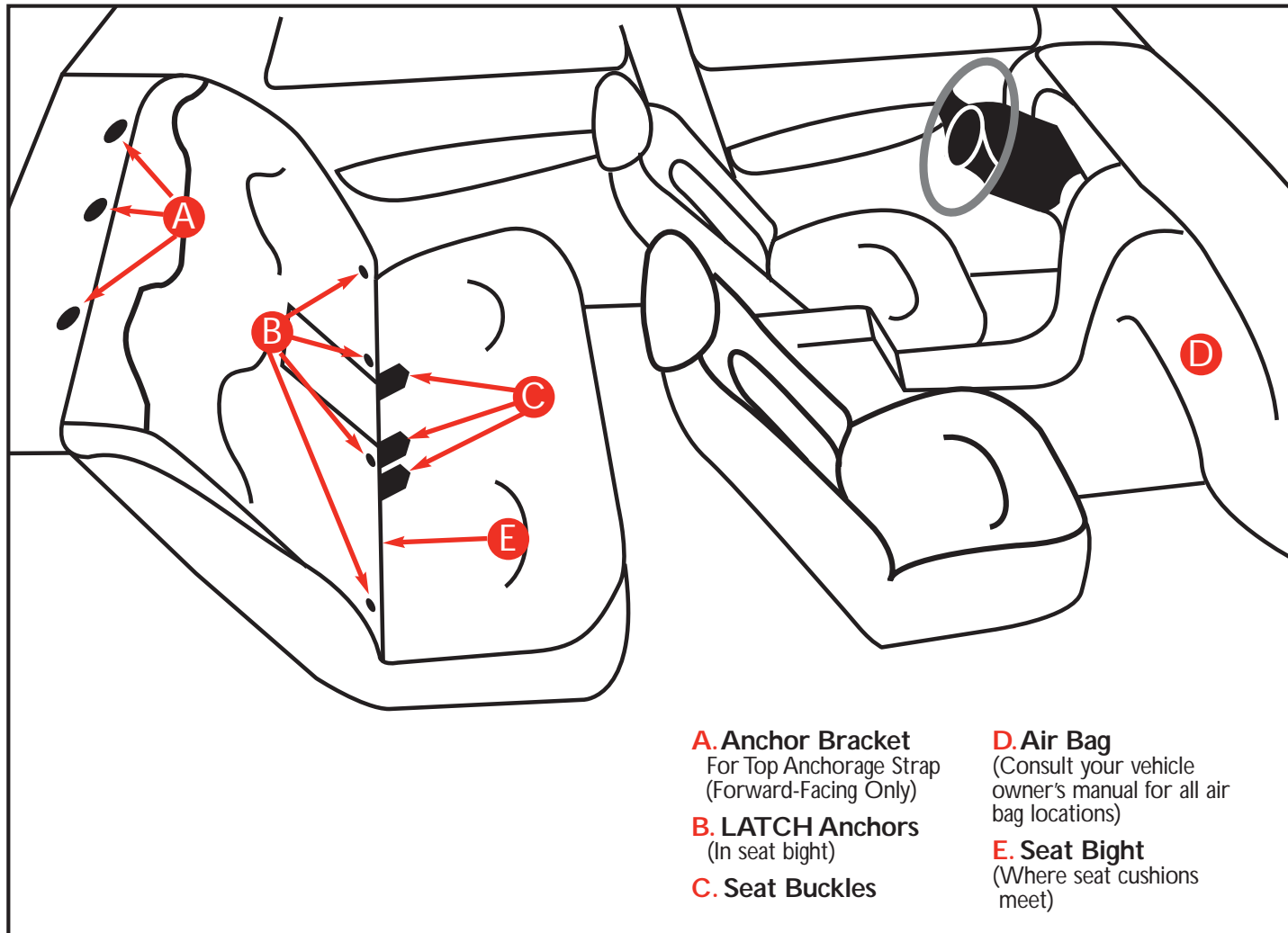

6

7

## Child Restraint Parts

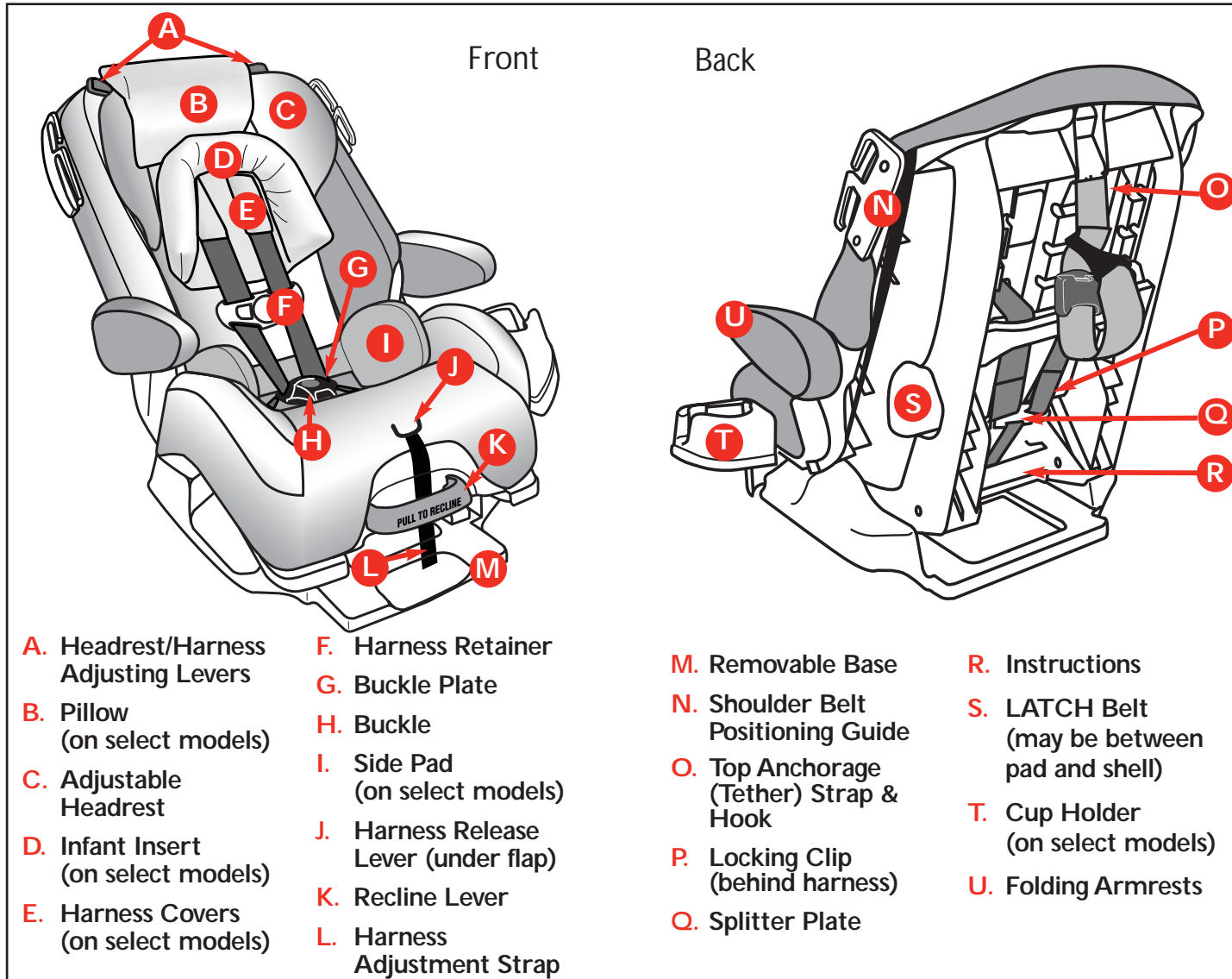

## Choosing Restraint and Position

Your child's height, weight and age determine how your child restraint should be placed in the vehicle and which restraint should be used.

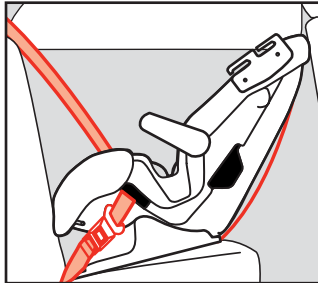

**5-35 lbs (2.3-16 kg)  
19-36 in. (48-91 cm)**

### Rear-Facing using 5-point harness

Child and child restraint face the back of the vehicle and are placed in the back seat.

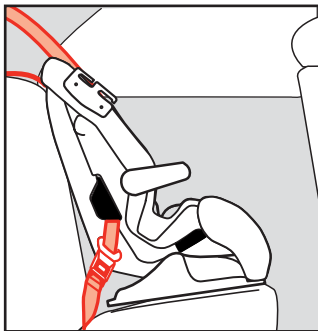

**22-40 lbs (10.1-18 kg)  
34-43 in. (85.1-110 cm)  
and Over 1 Year Old**

### Forward-Facing using 5-point harness

Child and child restraint face the front of the vehicle and are placed in the back seat.

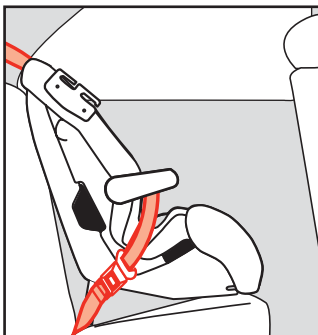

**40-100 lbs (18.1-45.4 kg)  
43-52 in. (110.1-132.1 cm)  
and Over 1 Year Old**

### Belt-positioning booster using vehicle lap/shoulder belt combination

Child and child restraint face the front of the vehicle and are placed in the back seat. 5-point Harness and Base are removed.

10

## Preparing Child Restraint to Fit Your Child

You **MUST** make these adjustments with your child before you install the child restraint in the vehicle.

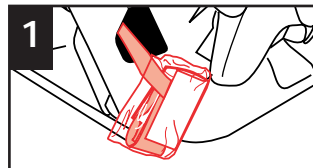

1 Make sure LATCH belt packaging is pulled free of child restraint shell.

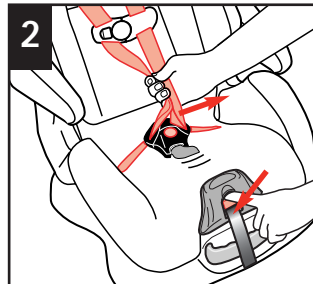

2 Loosen harness by pushing down on the harness release lever while pulling out on harness.

Depending on your model, the harness release lever may be under a flap on the pad in the front of restraint.

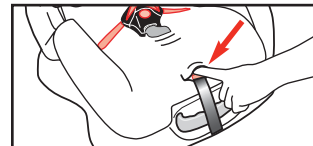

3 Press on harness retainer release button and pull apart.

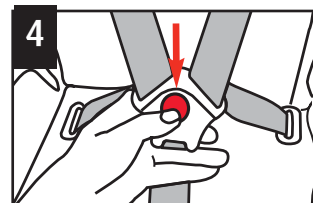
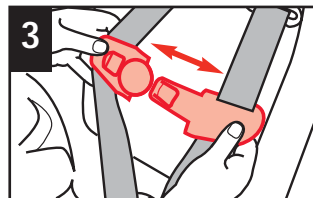

4 Press red button on buckle to release the buckle plates. Place harness over sides of child restraint.

11

continued on next page.



**5** Place the child's bottom and back flat against the child restraint. This will increase comfort and allow the harness to properly tighten.

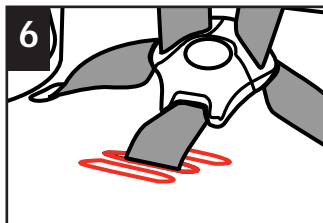

**6** Determine which of the three available buckle slots is both comfortable and snug. Refer to "Removal of Harness" and "Removal of Base" to adjust buckle.

### Check Harness/Headrest Height

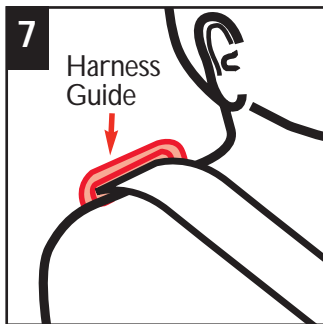

**Rear-Facing Position:** Harness guide must be **even with or just below** the shoulders.

If the harness is above the child's shoulders with the headrest in the lowest position, **do not** use this child restraint. Use an infant child restraint instead.

**Forward-Facing Position:** Harness guide must be **even with or just above** the shoulders.

If the harness is below the child's shoulders with the headrest in the 4th highest position, the child weighs at least 40 lbs. (18.1 kg) and is over 1 year old, convert the seat to a belt-positioning booster.

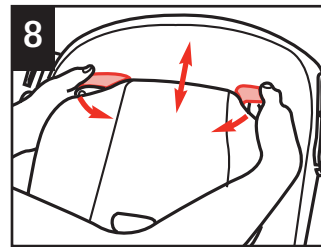

Rotate headrest/harness adjusting levers in. Move headrest up or down to adjust. Make sure headrest is locked into place. **NOTE:** The highest position is for belt-positioning use only.

### ⚠ WARNING:

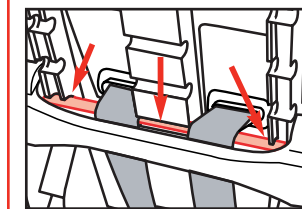

**Make sure metal bar is locked into position. Failure to do this can result in serious injury or death.**

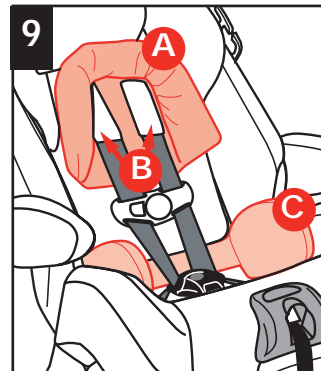

**Infant Insert (on select models):** When using insert (A), make sure insert does not cover your infant's face in any way. Remove the insert for older babies and toddlers. To remove the insert, unthread the harness from splitter plate, remove harness guides (see belt-positioning booster section), remove insert, and

rethread harness. Reverse to replace insert.

**Harness Covers (on select models):** Harness covers (B) help provide comfort to the neck. For Harness Covers to fit correctly, you may have to fit the upper ends of the covers through the harness slots. Removal is the same as for the infant insert.

**Side Pads (on select models):** Side pillows (C) help keep child snugly in the child restraint. To remove, unbuckle harness and remove side pillows.

## Securing Your Child in the Child Restraint



Position harness straps over the child's shoulders.

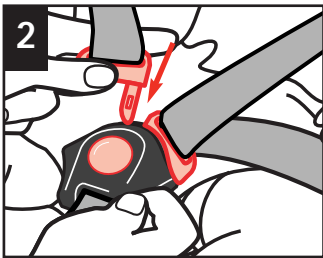

Push each buckle plate into buckle until you hear a "click". Remember to always pull up on harness straps to make sure buckle is locked tightly.

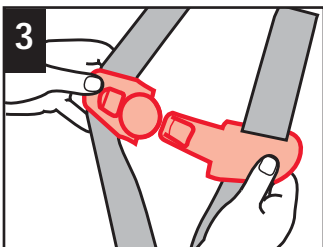

Snap the harness retainer together.

14

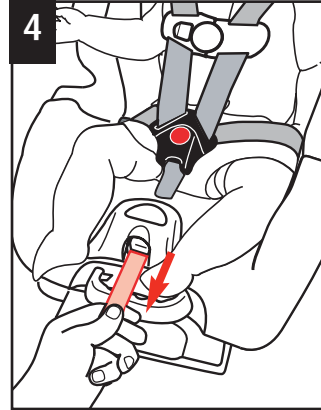

Pull on harness adjustment strap to tighten harness snugly.

**NOTE:** A snug strap should not allow any slack. It lies in a relatively straight line without sagging. It does not press on the child's flesh or push the child's body into an unnatural position.



Position the harness retainer at mid-chest (even with arm pits), away from the child's neck.

### **! WARNING:**

Failure to fasten and tighten the harness system correctly and snugly can result in serious injury or death.

15

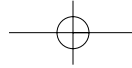

## Removing Your Child From the Child Restraint

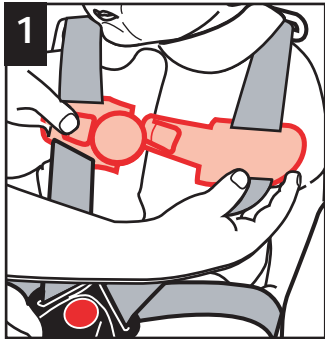

1 Press on release button and pull apart.

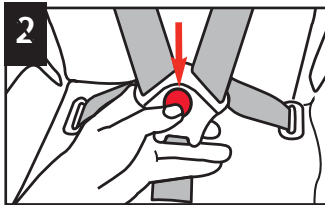

2 Press red button on buckle to release the buckle plates.

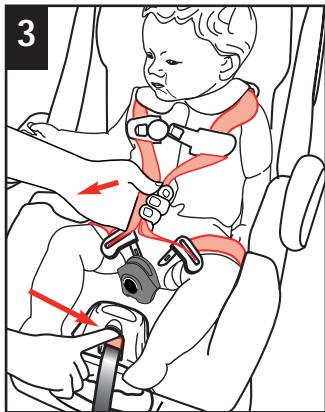

3 Push down on harness release button while pulling up on harness straps above the latch plates to loosen. Place harness over sides of child restraint. Remove child.

16

## Reclining the Child Restraint

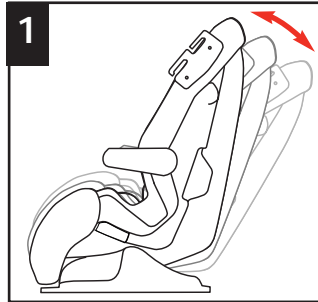

This child restraint has 3 recline positions when used with the base: Upright and Semi-reclined (forward facing only) and Reclined.

**Rear-facing** - Must be fully reclined.

**Forward-Facing** - Semi-reclined or upright.

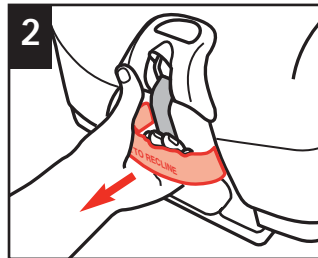

To fully recline, pull out on handle and push top of child restraint back.

For upright position, pull out on handle and pull child restraint up.

## Rotating Armrests

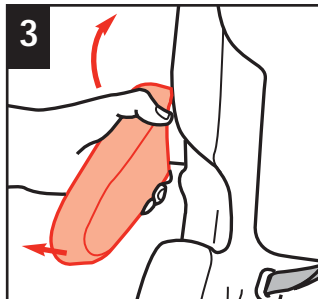

To rotate armrests up or down, pull out on arm and rotate. Make sure armrests lock into place.

17

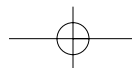

## Choosing LATCH or Vehicle Belts

### The LATCH System

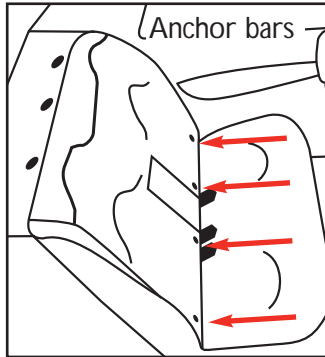

LATCH means **L**ower **A**nchors and **T**ethers for **C**hildren. Not all vehicles manufactured before September 2002 were equipped with LATCH.

The LATCH system allows a child restraint to be secured in the vehicle without using the vehicle belt system and can **ONLY** be used in vehicles that have the anchor bars installed.

Check your vehicle owners manual to see which seating positions may be equipped with the LATCH system.

### Vehicle Belts

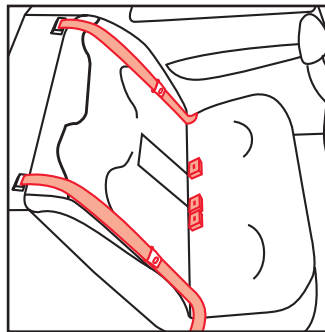

If LATCH is not an option, you will use your vehicle's belts. In most cases you will use the lap/shoulder belt combination. There are some vehicle belts that will not work with a child restraint or will require special attention. See next page for specific instructions.

## Knowing Your Vehicle Belts

Not all vehicle belts will work with this child restraint. You must determine if your vehicles belts are compatible with this child restraint. If you will use the LATCH system, refer to the LATCH section.

### ELR - Emergency Locking Retractor Belts

**Definition:** These belts only lock in a sudden stop or crash. To see if you have this type of belt, pull on the lap belt, let it return part way, then pull on it again. If it moves freely, it is an ELR belt and the child restraint could work loose during normal driving. Refer to your vehicle owner's manual.

ELR shoulder belts either require a locking clip or cannot be used with any child restraint. **Note:** You may use an ELR lap and shoulder belt when using this child restraint as belt-positioning booster; no locking clip is required.

ELR lap-only belts must be replaced with a manual belt; contact your vehicle dealer. A locking clip will not correct this problem.

### Automatic/Passive vehicle seat belts

Automatic (passive) 2-point belt has no lap belt. You must install a lap belt to secure a child restraint. You may also need to install an extra lap belt for an automatic 3-point belt. Refer to the vehicles owner's manual. A locking clip will not correct this problem.

### Vehicle belt too short

Contact your vehicle dealer for a seat belt extender.

### Belts in center of the door or side panel (A) or middle of the vehicle seat cushion (B).

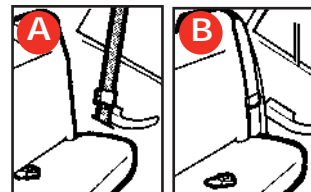

You must move the child restraint to another seating location. A locking clip will not fix this problem.

See Locking Clips section

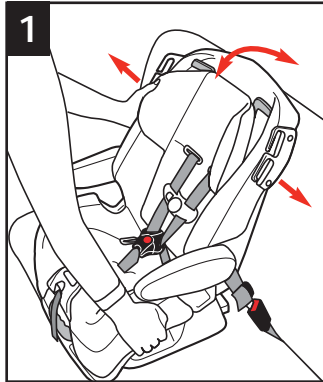

### Manual Belts

Manual lap belts are common in the center rear seat and can allow the child restraint to loosen when it is tilted or jarred. After tightening the lap belt securely, tilt and push the child restraint forward and to both sides. If no loosening occurs, your child restraint should be secure.

If loosening does occur, do the following: If the latch plate slides on the belt, turn the latch plate over. If the buckle slides, turn the buckle. Refasten the vehicle lap belt. The release button should face **out** after twisting so that it is easy to reach in an emergency.

If the lap belt continues to loosen, the child restraint must be moved to another location in the vehicle. A locking clip will not correct this problem; see your vehicle owner's manual.

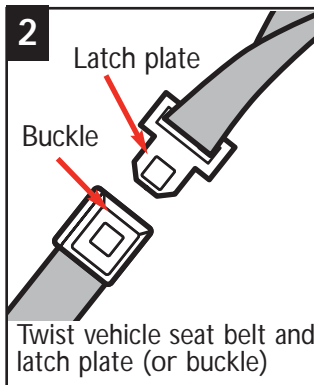

### **⚠ WARNING**

Failure to check and adjust the manual belt as described above can result in serious injury or death.

### Locking Clip

**NOTE:** The locking clip is located on the back of the seat. You do not need a locking clip when using this seat as a belt-positioning booster.

Remove the locking clip when the seat belt is not being used with a child restraint. **A locking clip will not fix all types of seat belt problems.**

Before you put your child restraint in the vehicle, buckle the lap/shoulder belt. Pull on the lap belt portion. If it loosens or slips, you must either use a locking clip to hold the seat belt tight or move the child restraint to another seating location.

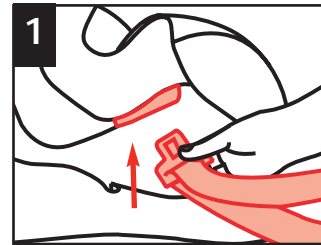

Thread both vehicle lap and shoulder belts through the slot (as shown) and out other side. Buckle. Pull up on shoulder belt until all slack is out and lap belt is tight.

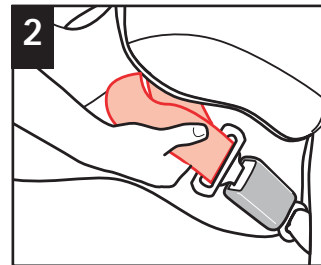

Grasp both vehicle belts together just behind the latch plate and unbuckle. **NOTE:** If the latch plate ends up behind the child restraint, grasp the belts to the outside of the child restraint, as close to the latch plate as possible.

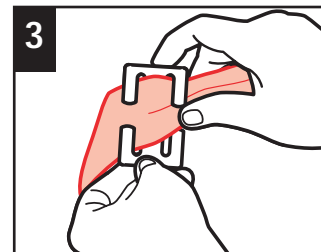

Thread both portions of the vehicle belt onto the locking clip, as close to the buckle plate as possible.

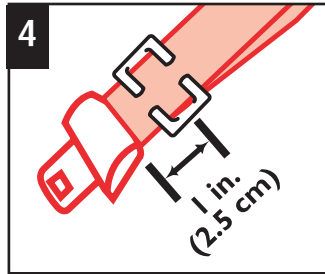

4 Position locking clip about 1 in. (2.5 cm) from vehicle belt's buckle plate.

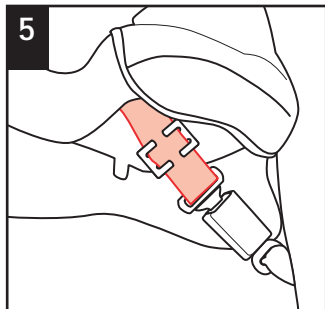

5 Rebuckle belt. Lap belt portion should now be tight. If not, remove locking clip and repeat all steps.

### Rear-Facing Use

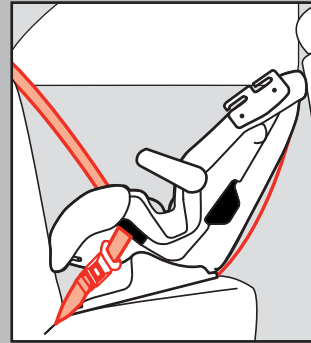

Lap/Shoulder Belt

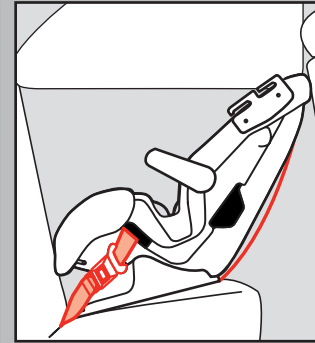

Lap Belt

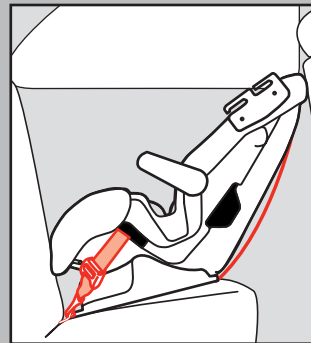

LATCH Belt

Refer to the "Choosing Restraint and Position" section to determine if your child should be in the rear-facing position.

Rear Facing Use: 5-35 lbs. (2.3-16 kg), 19-36" (48-91 cm).

### ⚠ WARNING:

This child restraint must always face the rear of the vehicle and be in the fully reclined position when the child weighs between 5-35 lbs. (2.3-16 kg) and is less than one year old.



Never place a child rear-facing in a seating position with an active frontal airbag. This can result in serious injury or death.

## Rear-Facing Installation

After deciding whether to use your Vehicle Belts or LATCH, be sure to read the warnings below as they pertain to both systems.

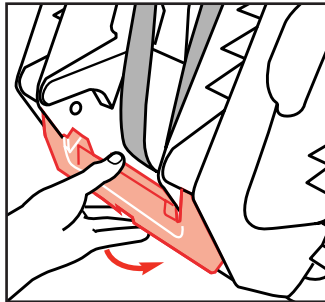

You may need to remove the base for narrow vehicle seats or airline use. See "Removing Base" in Belt-Positioning Booster section.  
To use the child restraint rear-facing without base, make sure recline stand is folded under seat.

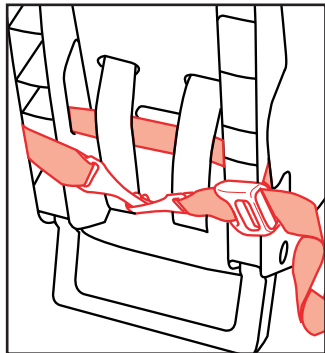

**NOTE:** Do not use the top anchorage strap in the rear-facing position. The top anchorage strap and hook should be placed under the child restraint.

When LATCH is not available, fasten belt hooks together behind the child restraint as shown.

### **⚠ WARNING:**

**A loose top anchorage (tether) strap can result in serious injury or death.**

**A loose LATCH system can result in serious injury or death.**

## Rear-Facing Installation with Vehicle Belt:

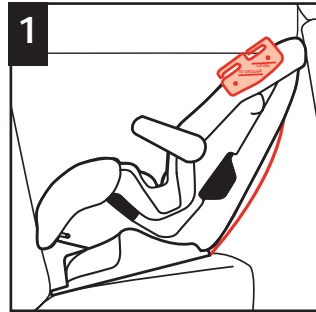

1 Connect and tighten harness straps prior to installing in vehicle. Place child restraint rear-facing in the back seat. With child restraint in the most reclined position, make sure level lines on shoulder belt positioning guide are level with ground. Adjust child restraint if needed.

**NOTE:** Tuck top anchorage strap and hook under the base or child restraint.

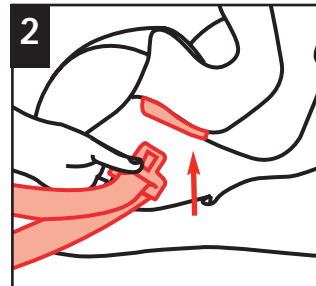

2 Thread the vehicle lap or lap/shoulder belt combination through the rear-facing belt slot.

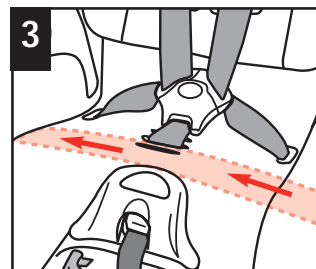

3 Thread vehicle seat belt **under** pad in front of crotch strap to the opposite side. Buckle vehicle belt.

**Do not place vehicle belt over child's legs.**

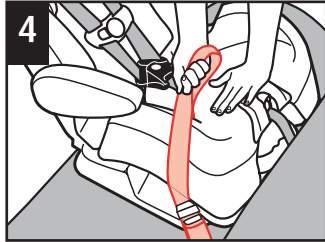

4 Push down firmly on the child restraint and pull up on belt to tighten. For a manual belt, refer to "Knowing your Vehicle Belt" section. Pull up on shoulder strap to remove any slack.

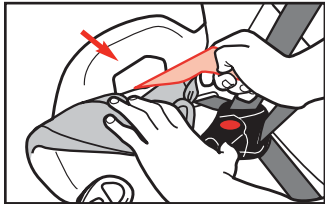

**NOTE:** In some cases, you may need to pull the pad off the front corner and expose the belt path. Tighten belt through belt path slot. Replace pad on corner.

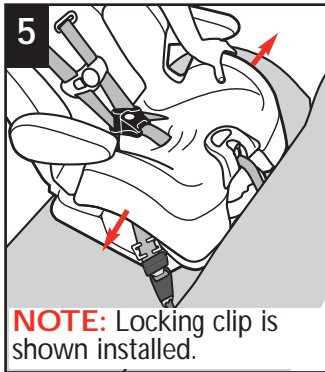

5 With weakest hand at belt path, tilt and push the child restraint forward and back, and from side to side. If the seat belts do not loosen, your child restraint should be secure.

**NOTE:** Locking clip is shown installed.

**NOTE:** Some "play" from front to back or about an inch from side to side is acceptable. If it moves more, review "Knowing your Vehicle Belts" and "The

Locking Clip" sections.

After checking for hot seat and buckles, secure child as described in "Securing Your Child in the Child Restraint" section.

**⚠ WARNING**

Using the child restraint in any vehicle seat where the lap belt cannot be tightened securely and properly or where it can be loosened by pulling on it can result in serious injury or death.

**Rear-Facing Installation with LATCH: Install LATCH Belt**

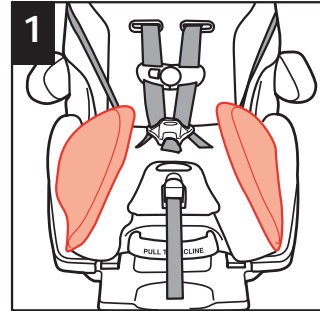

1 Do not use the LATCH system along with the adult lap or lap/shoulder belt.

To thread LATCH belts: Pull the seat pad off the front corners of shell.

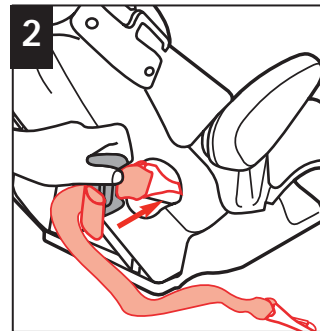

2 LATCH adjuster can be on either side, but belt should not be twisted.

Route entire LATCH belt through the upper slot in side of shell.

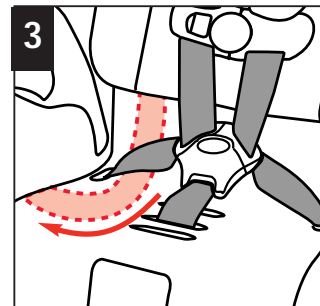

3 Reach under pad, pull one LATCH hook between rear harness slot and buckle strap.

Rear Facing Use: 5-35 lbs. (2.3-16 kg), 19-36" (48-91 cm).

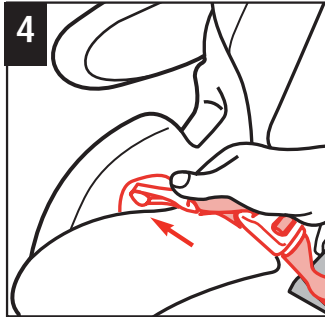

4 Push LATCH hook through the rear-facing belt path slot.

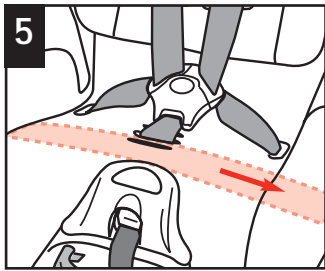

5 Pull other end of LATCH hook **under** pad in front of crotch strap to the opposite side.

**Do not place LATCH belt over child's legs.**

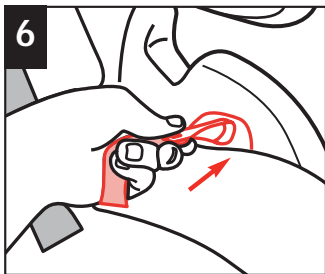

6 Push LATCH hook through the other rear-facing belt path slot.

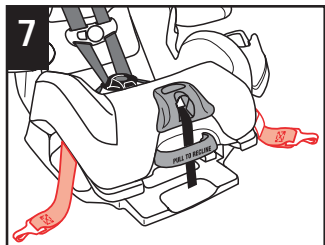

7 Put seat pad back over corners of shell.

Completed threading of the LATCH system rear-facing is shown.

### Rear-Facing Installation with LATCH: Install in Vehicle

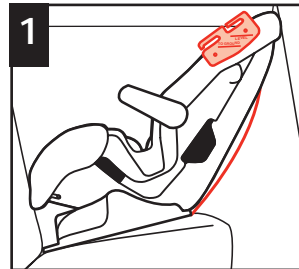

1 Connect and tighten harness straps prior to installing in vehicle. Place child restraint rear-facing in the back seat. With child restraint in the most reclined position, make sure level lines on shoulder belt positioning guide are level with ground. Adjust child restraint if needed.

**NOTE:** Tuck top anchorage strap and hook under the base or child restraint.

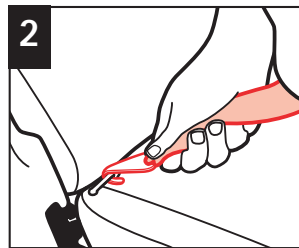

2 Fasten one LATCH belt hook to the anchor in the vehicle seat located in the vehicle seat bight. Repeat for other side of child restraint. See your vehicle owner's manual for more information.

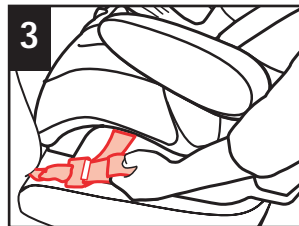

3 Push down firmly on the child restraint and pull up on the loop to tighten belt.

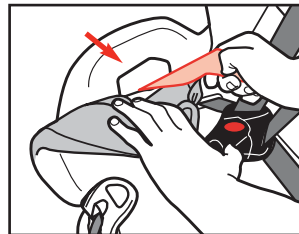

**NOTE:** In some cases, you may need to pull the pad off the front corner and expose the belt path. Tighten belt through belt path slot. Replace pad on corner.

Rear Facing Use: 5-35 lbs. (2.3-16 kg), 19-36" (48-91 cm).

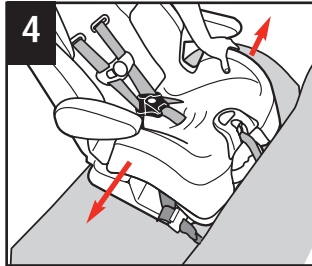

With weakest hand at belt path, tilt and push the child restraint forward and back, and from side to side. If the LATCH belts do not loosen, your child restraint should be secure.

**NOTE:** Some "play" from front to back or about an inch from side to side is acceptable. If the child restraint does not remain tight, do not use the child restraint in this seating location with this LATCH system.

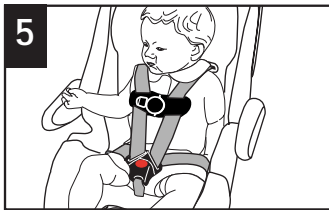

After checking for hot seat and buckles, place infant in child restraint. See "Securing your child in the child restraint" section.

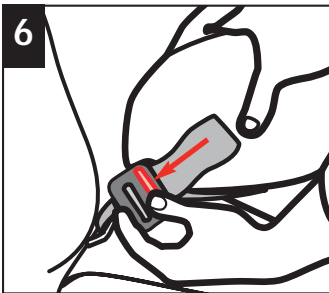

**To remove LATCH:** Remove child from child restraint. Press down firmly on adjuster side of child restraint and press release button to release tension. Unhook LATCH from bar by squeezing spring lever and twist hook.

**⚠ WARNING**

Using this child restraint in any vehicle seat where the LATCH belt cannot be tightened securely and properly or where it can be loosened by pulling on it, can result in serious injury or death.

**Forward-Facing Use**

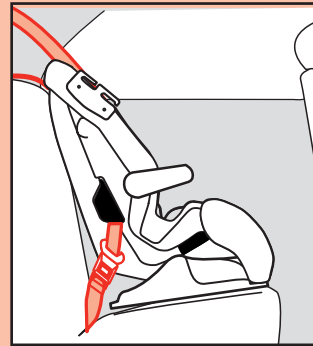

Lap/Shoulder Belt

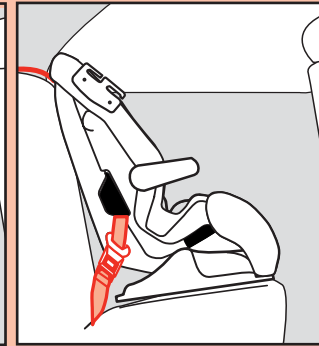

Lap Belt

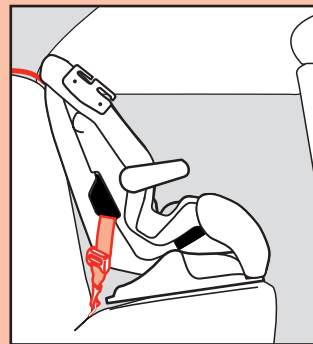

LATCH Belt

Refer to the "Choosing Restraint and Position" section to make sure your child is at the proper weight and height to face forward.

**⚠ WARNING:**

Using this child restraint in any vehicle seat where the lap or LATCH belts cannot be tightened securely and properly or where it can be loosened by pulling on it can result in serious injury or death.

Check vehicle instructions for more information about airbag/child restraint use.

Forward-Facing Use: 22-40 lbs. (10.1-18 kg), 34-43" (85.1-110 cm), Over 1 year of age.

## Forward-Facing Installation

After deciding whether to use your Vehicle Belts or LATCH, be sure to read the warnings below as they pertain to both systems.

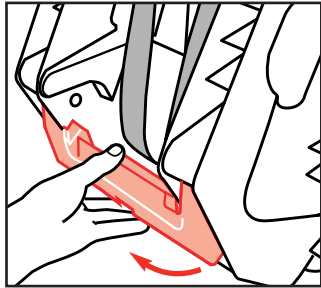

You may need to remove the base for narrow vehicle seats or airline use. See "Removing Base" in Belt-Positioning Booster section.

**NOTE:** To install the child restraint without the base, use either the recline mode or upright mode. For upright mode, rotate recline stand down and out, then push up to lock.

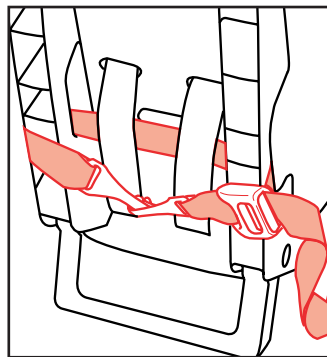

When LATCH is not being used, fasten belt hooks together behind the child restraint as shown.

### **⚠ WARNING:**

**Loose LATCH hooks can result in serious injury or death.**

## Forward-Facing Installation with Vehicle Belts:

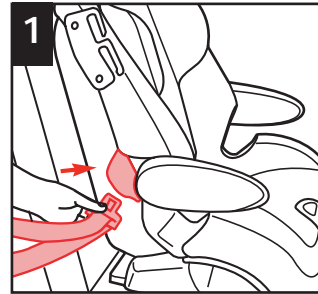

1 Connect and tighten harness straps prior to installing in vehicle.

Place child restraint **flush** against the back of the vehicle seat **forward-facing** in the back seat.

The recline position is to be used only to install the child restraint flush against the back of the vehicle seat back, if needed.

Thread the vehicle lap belt or lap/shoulder belt combination through the belt path and out other side. Buckle.

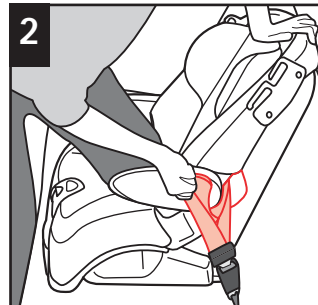

2 Place one knee in the child restraint and push down firmly while pulling up on belt to tighten. For a manual belt, refer to "Knowing your Vehicle Belt" section.

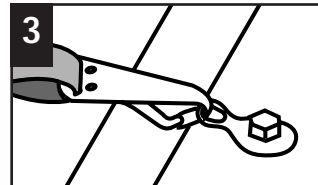

3 With knee still in child restraint, attach hook to anchor in vehicle. Push down firmly and tighten top anchorage strap.

To Adjust and other top anchorage strap information: See "Adjusting Top Anchorage Strap" section.

**NOTE:** If your vehicle does not have an anchor bracket, tuck the top anchorage strap and hook under the base or child restraint.

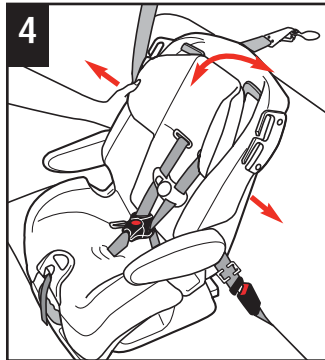

**NOTE:** Locking clip is shown installed.

With weakest hand at the belt path, tilt and push the child restraint from side to side. If the LATCH belts do not loosen, your child restraint should be secure.

**NOTE:** Some "play" from front to back or about an inch from side to side is acceptable. If it moves more, review "Knowing Your Vehicle Belts" and "The Locking Clip" sections.

**⚠ WARNING**

Using this child restraint in any vehicle seat where the lap belt cannot be tightened securely and properly or where it can be loosened by pulling on it can result in serious injury or death.



34

After checking for hot seat and buckles, place your child in the child restraint as described in the "Securing Your Child in the Child Restraint" section.

**Forward-Facing Installation with LATCH Belt: Install LATCH Belts**

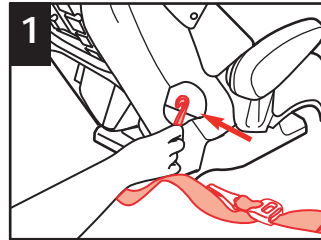

**NOTE:** Do not use LATCH system along with the adult lap or lap/shoulder belt.

Route LATCH belt through upper slot in side of shell.

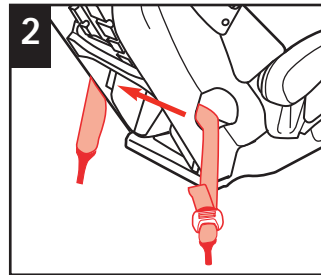

Pull one LATCH hook across the back and out the other side.

The LATCH adjuster can be on either side, but the belt should not be twisted.

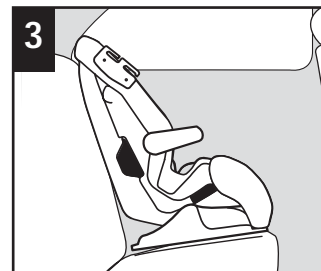

Connect and tighten harness straps prior to installing in vehicle. Place child restraint **flush** against the back of the vehicle seat **forward-facing** in the back seat.

The recline position is to be used only to install the child restraint flush against the back of the vehicle seat back, if needed.

35

*continued on next page.*

Forward-Facing Use: 22-40 lbs. (10.1-18 kg), 34-43" (85.1-110 cm), Over 1 year of age.

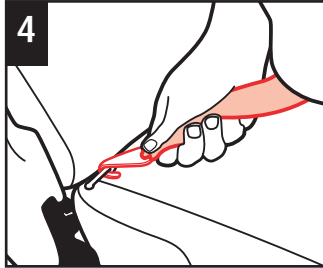

Fasten one LATCH belt hook to the anchor in the vehicle seat located in the vehicle seat bight. Repeat for other side of child restraint. See your vehicle owner's manual for locations and more information.

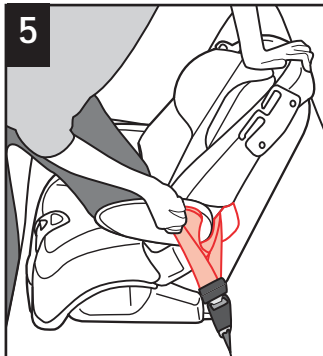

Place one knee in the child restraint and push down firmly while pulling up on the loop to tighten belt.

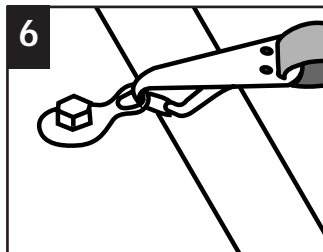

With knee still in child restraint, attach hook to anchor in vehicle. Push down firmly and tighten top anchorage strap.

To adjust top anchorage strap: See "Adjusting Top Anchorage Strap" section.

36

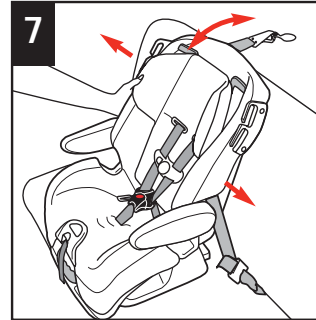

With weakest hand at belt path, tilt and push the child restraint forward and back and side to side. If the seat belts do not loosen, your child restraint should be secure.

**NOTE:** Some "play" from front to back or an inch or two from side to

side is acceptable.

If the child restraint does not remain tight, do not use the child restraint in this seating location with this LATCH system.

### ⚠ WARNING

**Using this child restraint in any vehicle seat where the LATCH belt cannot be tightened securely and properly or where it can be loosened by pulling on it, can result in serious injury or death.**

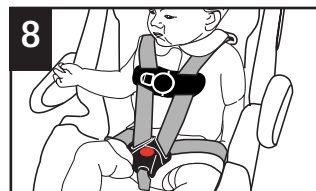

After checking for hot seat and buckles, place child in child restraint. See "Securing Your Child in the Child Restraint" section.

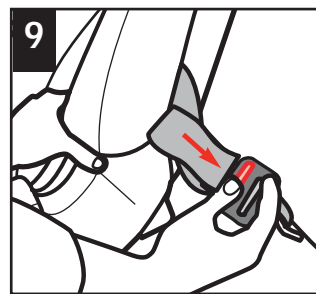

**To remove LATCH:** Remove child from child restraint. Press down firmly on adjuster side of child restraint and press release button to release tension. Unhook LATCH from bar by squeezing spring lever and twist hook.

37

Forward-Facing Use: 22-40 lbs. (10.1-18 kg), 34-43" (85.1-110 cm), Over 1 year of age.

## Adjusting the Top Anchorage Strap

The top anchorage strap (tether) is used for the forward-facing position only.

Most vehicles made after 9/1/99 already have the anchor hardware for a top anchorage strap. Refer to your owner's manual or call your dealer.

### Storage of Top Anchorage Strap:

**Rear-facing position:** Place top anchorage strap over the back of the child restraint with the anchor hook secured under the base or child restraint.

**Belt-Positioning Booster position:** Place top anchorage strap behind the seat with the anchor hook under the seat.

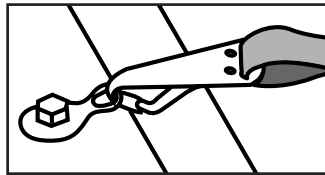

**To Attach Top Anchorage Strap:** Attach hook to anchor in vehicle.

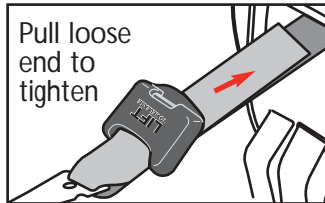

Pull loose end to tighten

**To Adjust Top Anchorage Strap:**  
**To tighten;** Put knee in child restraint and push down. Pull on free end of top anchorage strap.

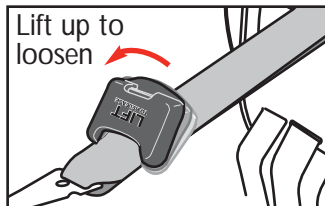

Lift up to loosen

**To loosen;** Lift up on top anchorage lock and push lock toward top anchorage hook.

## Belt-Positioning Booster Use



Lap/Shoulder Belt

Refer to the "Choosing Restraint and Position" section to make sure your child is at the proper weight and height to use the belt-positioning booster.

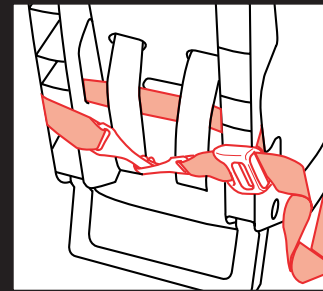

Do not use LATCH when using the Belt-Positioning Booster.

You **MUST** fasten the LATCH belt hooks together behind seat.

When your child is over 40 lbs. (18.1 kg) or 43" (110.1 cm) and over 1 year old, you must remove the harness and the base and use this seat as a belt-positioning booster.

### **WARNING**

**Loose LATCH hooks can result in injury or death.**

Belt-Positioning Booster Use: 40-100 lbs. (18.1-45.4 kg), 43-52" (110.1-132.1 cm), Over 1 year of age.

## Removal of Seat Base

Base must be removed for use as Belt-Positioning Booster.

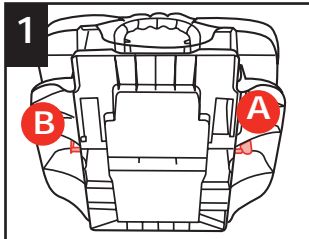

1 Move seat to fully reclined position. Push down on tab on right side of base (A).

From the other side, push on bar (B) and pull the bar completely out.

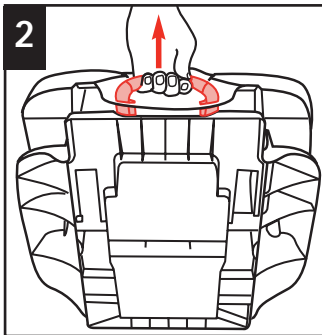
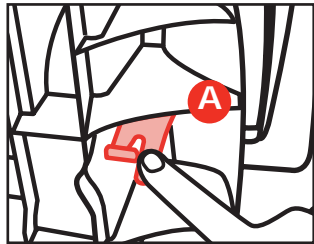

2 Pull on recline lever and lift shell off base. Store bar in base for future use.

## Removal of Harness

Harness must be removed for use as a Belt-Positioning Booster.

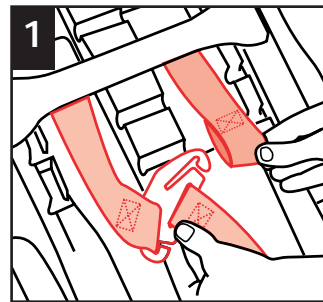

1 From the back of the seat, unfasten harness straps from splitter plate.

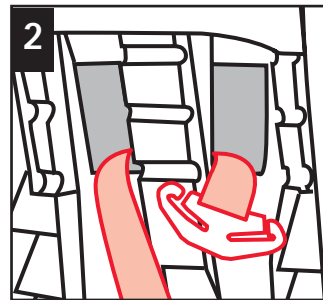

2 Store splitter plate by pushing it through one opening and out the other.

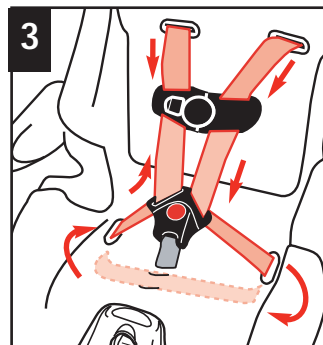

3 Pull harness through the slots from the front.  
 Unthread harness from the harness retainer.  
 Unthread harness from the buckle plates.  
 Pull harness out of shell.

continued on next page.

Belt-Positioning Booster Use: 40-100 lbs. (18.1-45.4 kg), 43-52" (110.1-132.1 cm), Over 1 year of age.

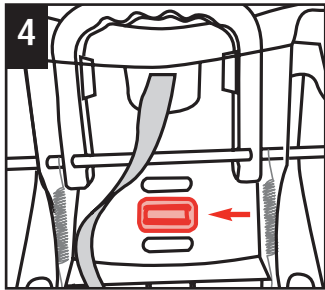

4 From bottom of seat, locate buckle's metal clip.

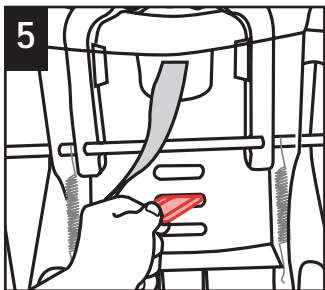

5 Insert metal clip up through the shell and pad.

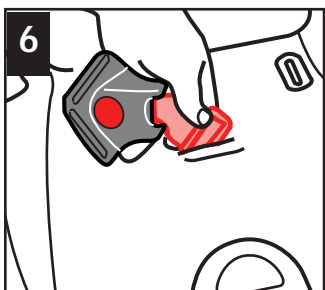

6 From the front, pull buckle free from shell and pad. Lock latch plates into buckle for future use.

### Belt-Positioning Booster Installation

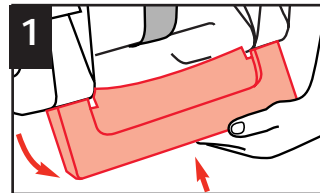

1 Child restraint must be in the full upright position. Rotate recline stand out and push upward to lock in position.



2 Place booster seat against the back of the vehicle seat. Tuck the top anchorage hook under the recline stand. Have child sit in seat with his back and bottom fully in the seat.

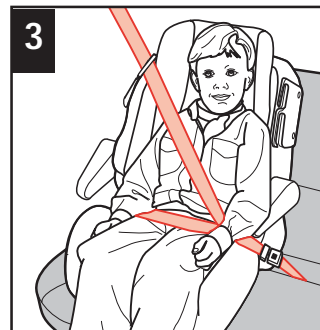

3 Place lap/shoulder belt across child's thighs. Lock buckle.

#### ⚠ WARNING

Use only the vehicle's lap and shoulder belt system when restraining the child in this booster seat. Failure to do this can result in serious injury or death.

Belt-Positioning Booster Use: 40-100 lbs. (18.1-45.4 kg), 43-52" (110.1-132.1 cm), Over 1 year of age.

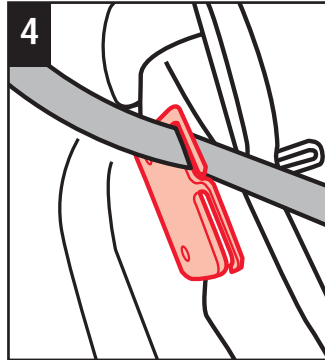

**4** Secure the shoulder belt through one of the notches in the shoulder belt positioning guide. The belt should cross the base of the child's neck and across the chest (not the face or neck). Pull up on the shoulder belt to tighten.

Check periodically to ensure your child has not moved out of position and loosened the shoulder belt.

**⚠ WARNING**

Check vehicle instructions for more information about airbag/child restraint use.

Do Not Use only the lap belt when using this seat as a belt-positioning booster without the internal harness.

The shoulder belt must always be adjusted snugly across the child's chest.

NEVER place the shoulder belt under the child's arms.

Failure to follow these warnings can result in serious injury or death to your child.



**Reinstall Harness and Base**

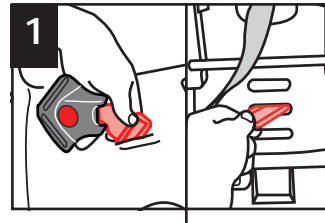

**1** Reinstall Harness: Fit the buckle strap down through the slot in the seat. Make sure buckle faces out. From the bottom of seat, pull buckle's metal clip completely through pad and shell.

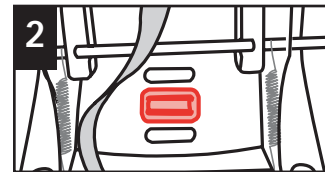

**2** Pull up on buckle to make sure buckle's metal plate is completely through the pad and shell.

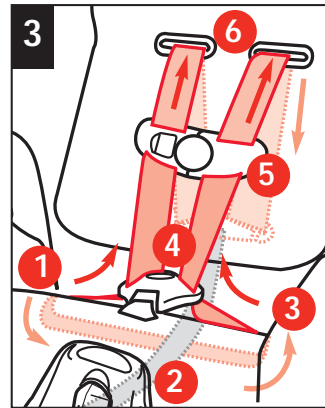

**3** Thread the harness down through slot on left side of shell (1), across bottom of seat (2) and up through slot on right side (3).

Thread one latch plate onto harness from back to front (4). Thread the harness retainer (5). Do the same to the other harness end. Make sure the harness is not twisted.

Push harness ends through upper slots in shell (6).

**⚠ WARNING**

Failure to place buckle's metal plate completely through pad and shell can result in serious injury or death to the child.

Failure to reattach the harness correctly, can result in serious injury or death.

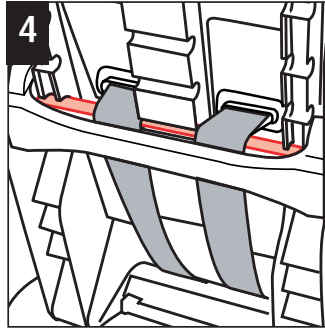

**4** Pull harness through the back. Make sure the harness goes **OVER** the metal bar, **BETWEEN** metal bar and plastic handle of the harness/headrest adjuster.

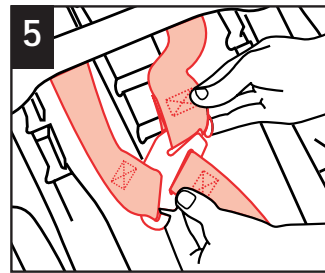

**5** Fit loops on harness ends onto the splitter plate.

**⚠ WARNING**  
**Failure to place harness over the metal bar, between bar and plastic handle of the harness/headrest adjuster in back, can result in serious injury or death.**

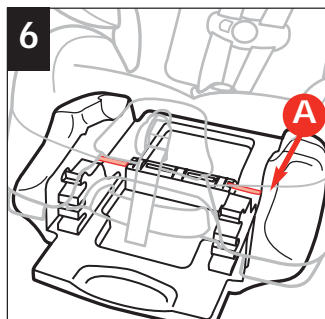

**Reinstall Base:**  
 Remove bar from base. Line up shell with base. Begin with the rounded end, push bar completely through hole, starting on the right side (A), until it locks in place. Refer to "Removal of Seat Base".

## Remove Seat Pad for Cleaning

Remove base and harness as described in the "Belt-Positioning Booster" section.

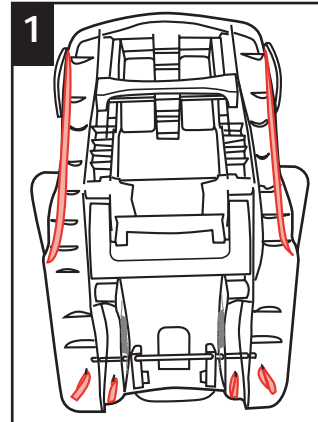

**1** From bottom of shell, release the elastic straps at the bottom of seat and the large elastic straps on the side of seat.

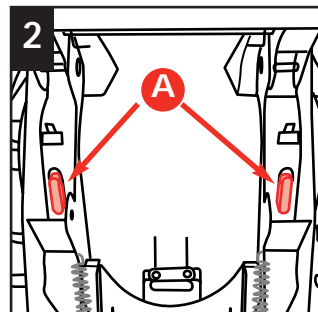
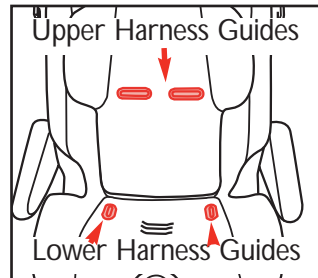

Adjust backrest to lowest position. Remove both lower harness guides (A) in bottom of seat under recline stand.

Push harness guide lip toward outside of shell with one hand while pulling harness guide from the front with the other.

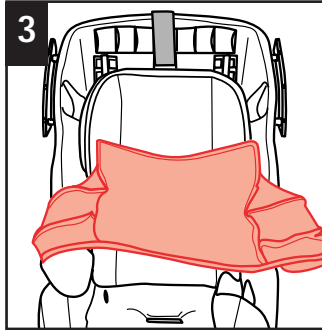

**3** Pull pad off the top of seat and off of headrest.

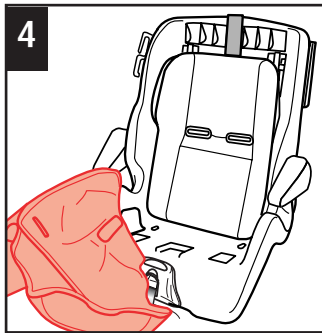

**4** Pull pad out from under buckle cover and work it off the shell. Slip off armrest pads.

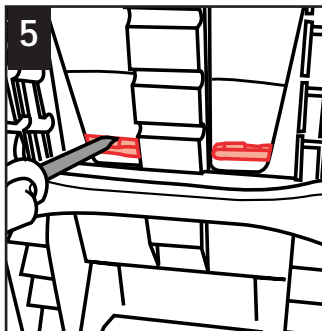

**5** From the back, use a screwdriver to press in on lip of upper harness guides and pop guides through the front. Pull cover off headrest.

Clean with warm sudsy water, rinse clean and air dry. Do not use bleach or use other harsh cleaners.

Replace seat pad by reversing order; put pad on headrest and replace upper harness guides. Starting from bottom of child restraint, slip pad on shell; tuck in pad around harness adjuster and over upper belt guides. Make sure pad is under headrest and replace lower harness guides. Rethread harness (see belt-positioning booster section).

## Trouble Shooting

**✓1. If your child restraint is not held securely by the belt:**

Press down firmly on the child restraint and remove all the slack in the belt. Make sure the belt buckle is not up against the child restraint where the belt cannot be tightened. Review Locking Clip section and Top Anchorage Strap Section. If you cannot secure the child restraint tightly, move it to another seating location.

**✓2. If the child restraint buckle or harness adjustment lever sticks or you cannot get the straps tight enough around child:**

**DO NOT LUBRICATE.** Check around lever and retractor for dropped food, sticky spilled drinks, dirt, leaves, etc. Clean with warm water and/or remove object with tweezers. If you cannot get the harness to adjust and remain tight with the buckle securely locked, do not use the child restraint.

**✓3. If your harness twists or ropes:** Straighten the harness each time you put your child in the seat to help prevent twisting. Lock the buckle and tighten harness and it will be ready for next use.

**✓4. If your infant sits too upright in the rear-facing position:** If your vehicle seat slopes so much that your

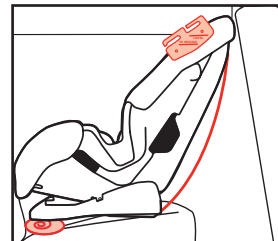

infant is sitting upright, you may place a rolled towel under the front of the child restraint so that the level line on the shoulder belt positioning guide is level (horizontal). Check often to be sure padding is still in place and the vehicle belt is tight.

### ⚠ WARNING

Using padding that tilts the base of the child restraint farther back than the level-to-ground line can result in serious injury or death.

## Warranty

Dorel Juvenile Group, Inc. (DJG) warrants this product to the original retail purchaser as follows:

This product is warranted against defective materials or workmanship for seven years from the date of original purchase. **An original receipt is required to validate your warranty.** DJG will, at its option, provide replacement parts or replace this product. DJG reserves the right to substitute if the part or model has been discontinued.

To make a claim under this warranty you may contact us at [www.djgusa.com](http://www.djgusa.com), fax us at 1-800-207-8182 24 hours a day, write to DJG, Consumer Relations Department, P. O. Box 2609, Columbus, IN 47202-2609, or call 1-800-544-1108 from 7:00 a.m. to 6:00 p.m. EST Monday through Thursday and from 7:00 a.m. to 4:30 p.m. on Friday. **Proof of purchase is required and shipping charges are the responsibility of the consumer.**

### Warranty Limitations:

This warranty does not include damages which arise from misuse or abuse of this product.

### Limitation of Damages:

The warranty and remedies as set forth are exclusive and in lieu of all others, oral or written, expressed or implied. In no event will DJG or the dealer selling this product be liable to you for any damages, including incidental or consequential damages, arising out of the use or inability to use this product.

### Limitation of warranties and other warranty terms and state law rights:

Any implied warranties, including implied warranties of the merchantability and fitness for a particular purpose, shall be limited to the duration and terms of the express written warranty. Some states do not allow limitations as to how long an implied warranty lasts or the exclusion or limitation of incidental or consequential damages, so the above limitations may not apply to you. This warranty gives you specific legal rights, and you may have other rights, which vary from state to state. Neither DJG nor the dealer selling this product authorized any person to create for it any other warranty, obligation, or liability in connection with this product.

PLEASE COMPLETE AND MAIL THE PRE-ADDRESSED OWNER REGISTRATION CARD WITHIN (30) DAYS OF PURCHASE TO EXPEDITE WARRANTY CLAIMS AND TO VERIFY THE ORIGINAL DATE OF PURCHASE.

## Replacement Parts Order Form

Complete the form below. Your model number with color code and manufacturer date code MUST be included on the form to ensure proper replacement parts. Your model number with color code and the date code can be found on a sticker on the side of child restraint. Payment in U.S. dollars must accompany your order. Choose parts needed from the list on the next page

Return the form with payment to:

**Dorel Juvenile Group, Inc.**  
**Consumer Relations Department**  
**P.O. Box 2609**  
**Columbus, IN 47202-2609**

Fax orders to: 1-800-207-8182

Please make money orders payable to Dorel Juvenile Group, Inc. Fill in the area below to charge to Visa or Mastercard. We do not accept personal checks or Discover Card. All outside of U.S. and Canada MUST use credit card.

Ship To (Please Print): \_\_\_\_\_

Name: \_\_\_\_\_

Address: \_\_\_\_\_

City: \_\_\_\_\_

State/Province: \_\_\_\_\_ Zip \_\_\_\_\_

Telephone: \_\_\_\_\_

Email Address: \_\_\_\_\_

**We **MUST** have this information to process your order:**  
**Model Number (5 digits & 3 letters):** \_\_\_\_\_  
**Manufacture Date (mm/dd/yyyy):** \_\_\_\_\_